



The Royale Collection

Aluminium windows and doors

58BW

Optio Casement Window

Strong, secure, superior.

Built to the highest UK standards, this effective and high performance solution offers clean lines and advanced functionality. Available in a 70mm frame depth, casement windows are the perfect choice for both residential and light commercial projects, whether new build or renovation. Windows can also be made to project in or out.



DESIGN FEATURES

- Certified under the Secured By Design scheme
- Tested to PAS 24
- Green guide rated B
- Integrated deep head profiles for ease of trickle ventilation
- Unique polyamide thermal break design to improve thermal performance

OPTIONS

- 70mm frame depth
- Project in or project out options
- Externally glazed to accommodate low and high rise projects
- Glazing 24mm – 40mm
- Available in a range of single or dual colour and anodised finishes
- Available in the following aesthetics: Chamfered and Square
- Available in the following configurations: top hung, side hung, bottom hung, fixed light, multi-light and French casement
- Available for Lifetime Homes (LFT)
- Double beaded option allowing for internal glazing without the use of dummy vents
- Dedicated fixing straps for ease of installation
- Designed with a Euro groove to accommodate standard locking hardware

SPECIFICATIONS

Performance and accreditation	Outward opening
U-value (double glazing)	1.4 W/m ² K
U-value (triple glazing)	1.2 W/m ² K
Window energy rating (WER)	B - C
Green guide rating	A rated
Acoustic performance (dB)	Rw (C;Ctr) 42 (-1;-5) dB
Air tightness (Pa)	Class 4 (600 Pa)
Water tightness (Pa)	Class 9a (600 Pa)
Wind load (Pa)	Class E2400 (2400 Pa)
Security	PAS 24
3rd party certification	Q-mark
Secured by design	Yes

Configurations

Opening	Open out
Top hung	✓
Side hung	✓
Bottom hung	✓
Fixed light	✓
Multi-light	✓
French casement	✓

Size limits

Top hung (max weight)	180 Kg
Side hung (max weight)	55 Kg
Bottom hung (max weight)	60 Kg (3 hinges)
Fixed light (max weight)	250 Kg

System features

Frame depth	70mm
Dual colour option	✓
Multi-point locking	✓
Glazing options	Internal and external bead
Glazing thickness	24mm - 40mm
Sightline (Frame to Vent)	75mm
Sightline (Vent to Mullion)	89mm
Sightline (Fixed Light)	43mm

Aesthetics

Chamfered	✓
Square	✓

U-Value (Double Glazing) - Windows are calculated using EN ISO 10077
 - Part 2, 1230mm x 1480mm Side hung next to fixed light with Ug: 1.0 W/m²K using AW603 outerframe and AW610 vent
 U-Value (Triple Glazing) - Windows are calculated using EN ISO 10077
 - Part 2, 1230mm x 1480mm Side hung next to fixed light with Ug: 0.7 W/m²K using AW603 outerframe and AW610 vent
 Green Guide Rating - Calculated using the Green Guide 2008 ratings for domestic windows, Powder Coated Aluminium window (Profile <0.88kg/m) double glazed
 Acoustic Performance (dB) - Tested using AW605 outerframe and AW620 vent, 10/16/8.4mm Acoustic Laminated Glass
 Top Hung (max weight) - Based upon Sterling SP126 top hung friction stay
 Side Hung (max weight) - Based upon Securistyle Sterling SP5H16 side hung friction stay
 Bottom Hung (max weight) - Based upon 3 x RW20M hinges

CAD CROSS SECTIONS

CHAMFERED

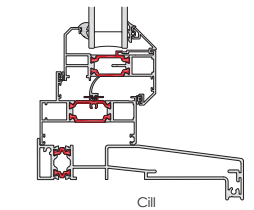
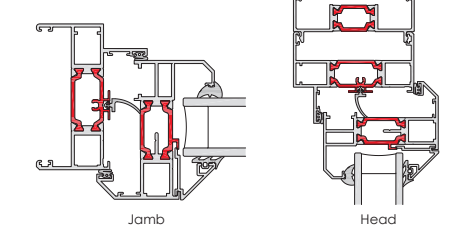

SQUARE

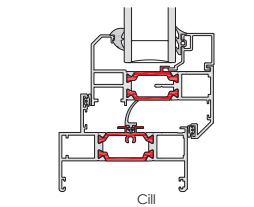
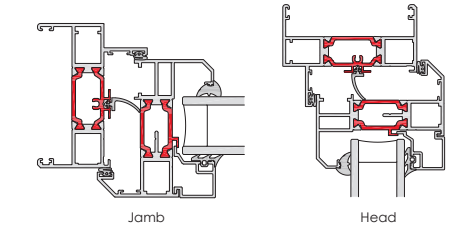

58BW

Optio Contemporary Window

Modern, stylish, flexible.

Built to the highest UK standards, this effective and high performance solution offers clean lines and advanced functionality. Available in a 70mm frame depth, casement windows are the perfect choice for both residential and light commercial projects, whether new build or renovation. Windows can also be made to project in or out.



DESIGN FEATURES

- Certified under the Secured By Design scheme
- Tested to PAS 24
- Green guide rated B
- Integrated deep head profiles for ease of trickle ventilation
- Unique polyamide thermal break design to improve thermal performance

OPTIONS

- 70mm frame depth
- Project in or project out options
- Externally glazed to accommodate low and high rise projects
- Glazing 24mm – 40mm
- Available in a range of single or dual colour and anodised finishes
- Available in the following aesthetics: Chamfered and Square
- Available in the following configurations: top hung, side hung, bottom hung, fixed light, multi-light and French casement
- Available for Lifetime Homes (LFT)
- Double beaded option allowing for internal glazing without the use of dummy vents
- Dedicated fixing straps for ease of installation
- Designed with a Euro groove to accommodate standard locking hardware

SPECIFICATIONS

Performance and accreditation	Outward opening
U-value (double glazing)	1.4 W/m ² K
U-value (triple glazing)	1.2 W/m ² K
Window energy rating (WER)	B - C
Green guide rating	A rated
Acoustic performance (dB)	Rw (C;Ctr) 42 (-1;-5) dB
Air tightness (Pa)	Class 4 (600 Pa)
Water tightness (Pa)	Class 9a (600 Pa)
Wind load (Pa)	Class E2400 (2400 Pa)
Security	PAS 24
3rd party certification	Q-mark
Secured by design	Yes

Configurations

Opening	Open out
Top hung	✓
Side hung	✓
Bottom hung	✓
Fixed light	✓
Multi-light	✓
French casement	✓

Size limits

Top hung (max weight)	180 Kg
Side hung (max weight)	55 Kg
Bottom hung (max weight)	60 Kg (3 hinges)
Fixed light (max weight)	250 Kg

System features

Frame depth	70mm
Dual colour option	✓
Multi-point locking	✓
Glazing options	Internal and external bead
Glazing thickness	24mm - 40mm
Sightline (Frame to Vent)	75mm
Sightline (Vent to Mullion)	89mm
Sightline (Fixed Light)	43mm

Aesthetics

Chamfered	✓
Square	✓

U-Value (Double Glazing) - Windows are calculated using EN ISO 10077 - Part 2, 1230mm x 1480mm Side hung next to fixed light with Ug: 1.0 W/m²K using AW603 outerframe and AW610 vent
 U-Value (Triple Glazing) - Windows are calculated using EN ISO 10077 - Part 2, 1230mm x 1480mm Side hung next to fixed light with Ug: 0.7 W/m²K using AW603 outerframe and AW610 vent
 Green Guide Rating - Calculated using the Green Guide 2008 ratings for domestic windows, Powder Coated Aluminium window (Profile <0.88kg/m) double glazed
 Acoustic Performance (dB) - Tested using AW605 outerframe and AW620 vent, 10/16/8.4mm Acoustic Laminated Glass
 Top Hung (max weight) - Based upon Sterling SP126 top hung friction stay
 Side Hung (max weight) - Based upon Securistyle Sterling SP5H16 side hung friction stay
 Bottom Hung (max weight) - Based upon 3 x RW20M hinges

CAD CROSS SECTIONS

CHAMFERED

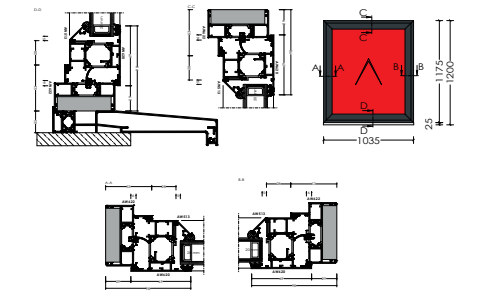

SQUARE

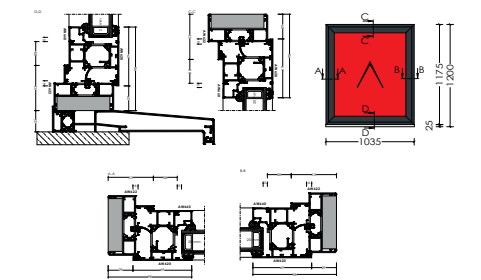

58BW

Optio Tilt Before Turn Window

Innovative, versatile, intelligent.

Built to the highest UK standards, this effective and high performance solution offers clean lines and advanced functionality. Available in a 70mm frame depth, tilt before turn windows are the perfect choice for both residential and light commercial projects, whether new build or renovation. Windows can also be made to project in or out.



DESIGN FEATURES

- Certified under the Secured By Design scheme
- Tested to PAS 24
- Green guide rated B
- Integrated deep head profiles for ease of trickle ventilation
- Unique polyamide thermal break design to improve thermal performance

OPTIONS

- 70mm frame depth
- Project in or project out options
- Internally or externally glazed to accommodate low and high rise projects
- Glazing 24mm – 40mm
- Available in a range of single or dual colour and anodised finishes
- Available in the following aesthetics: Chamfered and Square
- Available in the following configurations: fixed light
- Dedicated fixing straps for ease of installation
- Designed with a Euro groove to accommodate standard locking hardware

SPECIFICATIONS

Performance and accreditation	Inward opening
U-value (double glazing)	1.4 W/m ² K
U-value (triple glazing)	1.2 W/m ² K
Window energy rating (WER)	B - C
Green guide rating	A rated
Acoustic performance (dB)	Rw [C;Ctr] 42 (-1;-5) dB
Air tightness (Pa)	Class 4 (600 Pa)
Water tightness (Pa)	Class 9a (600 Pa)
Wind load (Pa)	Class E2400 (2400 Pa)
Security	PAS 24
3rd party certification	Q-mark
Secured by design	Yes

Configurations

Opening	Open in
Fixed light	✓

Size limits

Top hung (max weight)	180 Kg
Side hung (max weight)	55 Kg
Bottom hung (max weight)	60 Kg (3 hinges)
Fixed light (max weight)	250 Kg

System features

Frame depth	70mm
Dual colour option	✓
Multi-point locking	✓
Glazing options	Internal and external bead
Glazing thickness	24mm - 40mm
Sightline (Frame to Vent)	75mm
Sightline (Vent to Mullion)	89mm
Sightline (Fixed Light)	43mm

Aesthetics

Chamfered	✓
Square	✓

U-Value (Double Glazing) - Windows are calculated using EN ISO 10077 - Part 2, 1230mm x 1480mm Side hung next to fixed light with Ug: 1.0 W/m²K using AW603 outerframe and AW610 vent
 U-Value (Triple Glazing) - Windows are calculated using EN ISO 10077 - Part 2, 1230mm x 1480mm Side hung next to fixed light with Ug: 0.7 W/m²K using AW603 outerframe and AW610 vent
 Green Guide Rating - Calculated using the Green Guide 2008 ratings for domestic windows, Powder Coated Aluminium window (Profile <0.88kg/m) double glazed
 Acoustic Performance (dB) - Tested using AW605 outerframe and AW620 vent, 10/16/8.4mm Acoustic Laminated Glass
 Top Hung (max weight) - Based upon Sterling SPT26 Top hung friction stay
 Side Hung (max weight) - Based upon Securistyle Sterling SPSH16 side hung friction stay
 Bottom Hung (max weight) - Based upon 3 x RW20M hinges

CAD CROSS SECTIONS

CHAMFERED

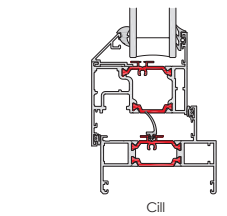
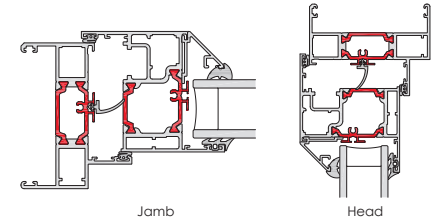

SQUARE

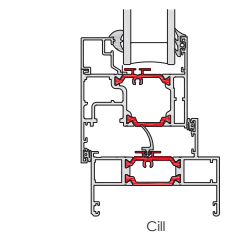
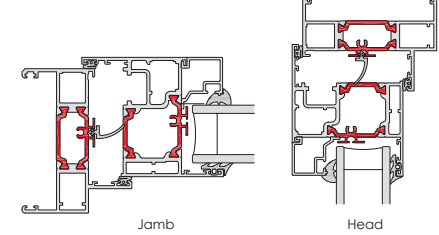

58BD

Optio Entrance Door

Popular, reliable, secure.

Available in a wide range of styles and formats, our stylish aluminium entrance door system is suitable for both light and medium-duty use. Designed with security and flexibility front of mind, every door in the range is available in single and double configurations making them ideal for almost any application.



DESIGN FEATURES

- Certified under the Secured By Design scheme
- Tested to PAS 24
- Multi-point locking mechanism
- Designed to incorporate standard and security hardware using the same prep detail
- Cloaking feature conceals lock and prevents any access to locking points

OPTIONS

- Glazing 24mm – 40mm
- 58mm or 70mm frame depth to accommodate varying types of applications
- Low threshold option for Part M – Building regulation
- Available in a range of single or dual colour and anodised finishes
- Available for new build or refurbishment projects
- Available in single or double door configuration

SPECIFICATIONS

Performance & accreditations	Single open in	Single open out
Air permeability	Class 4 (600 Pa)	Class 4 (600 Pa)
Water penetration	Class 3a (100 Pa)	Class 7a (300 Pa)
Wind resistance	Class A3 (1200 Pa)	Class AE2400 (2400 Pa)
Building regulations part L compliant	✓	✓
Building regulations part M compliant	✓	✓
Building regulations part Q compliant	✓	✓
*U-value (double glazing)	1.7 W/m²K	1.7 W/m²K
†U-value (triple glazing)	1.4 W/m²K	1.4 W/m²K
Fire (EN1631-3)	npd	npd
Smoke (EN1631-3)	npd	npd
Security	PAS 24	PAS 24
3rd party certification	Q-mark	Q-mark
Secured by design	Yes	Yes
Durability EN1191 category	50,000 Cycles	50,000 Cycles

System depth

Units (mm)	58mm and 70mm	58mm and 70mm
------------	---------------	---------------

Design features

Thermally broken	✓	✓
Low threshold	✓	✓
Panel door	✓	✓
Feature design - rounded contours	✓	✓
Sightline (Head)	120mm	120mm
Sightline (Cill)	111mm	111mm
Sightline (Jamb)	120mm	120mm
Sightline (Meeting Stile)	208mm	208mm

Hardware

Multi-point locking	✓	✓
Barrel hinges	✓	✓

Finishes

Single colour	✓	✓
Dual colour	✓	✓
Textured	✓	✓

Maximum sizes and weights

Maximum door leaf size	1020mm x 2160mm	1020mm x 2160mm
Maximum door leaf weight	90 Kg	90 Kg
Maximum glazing thickness	24mm - 40mm	24mm - 40mm

Double open in	Double open out
Class 2 (300 Pa)	Class 2 (300 Pa)
Class 7a (300 Pa)	Class 9a (600 Pa)
Class A2400 (2400 Pa)	Class A2400 (2400 Pa)
✓	✓
✓	✓
✓	✓
1.7 W/m²K	1.7 W/m²K
1.5 W/m²K	1.5 W/m²K
npd	npd
npd	npd
PAS 24	PAS 24
Q-mark	Q-mark
Yes	Yes
50,000 Cycles	50,000 Cycles

58mm and 70mm	58mm and 70mm
---------------	---------------

✓	✓
✓	✓
✓	✓
✓	✓
120mm	120mm
111mm	111mm
120mm	120mm
208mm	208mm

✓	✓
✓	✓
✓	✓

1020mm x 2160mm	1020mm x 2160mm
90 Kg	90 Kg
24mm - 40mm	24mm - 40mm

CAD CROSS SECTIONS

SQUARE

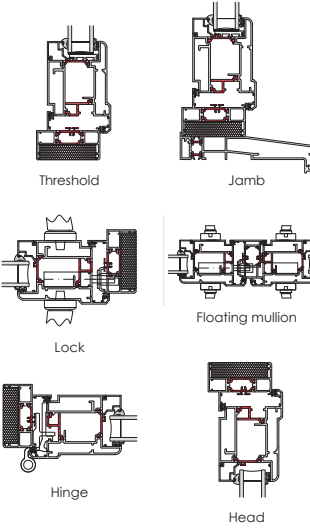

CHAMFERED

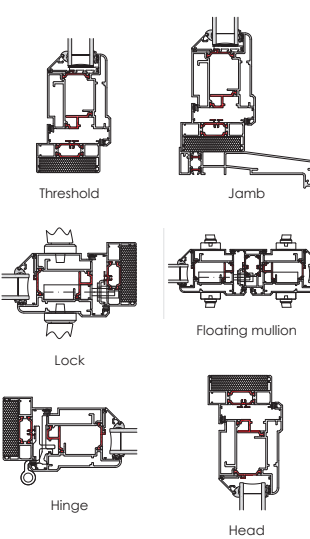

* U-Value (Double Glazing) - Single Doors are calculated using EN ISO 10077 - Part 2, 1000mm x 2180mm Single Door with Ug: 1.0 W/m²K using AW604 outerframe and AD200/AD201 vent. Double Doors are calculated using EN ISO 10077 - Part 2, 2000mm x 2180mm Single Door with Ug: 1.0 W/m²K using AW604 outerframe and AD200/AD201 vent.

† U-Value (Triple Glazing) - Single Doors are calculated using EN ISO 10077 - Part 2, 1000mm x 2180mm Single Door with Ug: 0.7 W/m²K using AW604 outerframe and AD200/AD201 vent. Double Doors are calculated using EN ISO 10077 - Part 2, 2000mm x 2180mm Single Door with Ug: 0.7 W/m²K using AW604 outerframe and AD200/AD201 vent.



BSC94

Optio Inline Sliding Door

Modern, versatile, premium.

A premium sliding door with slim sightlines, available in a variety of sliding configurations using single, dual and triple track systems. The BSC94 offers high levels of performance, from thermal U-Values of 1.5W/m²K (triple glazed), and with panel weights up to 400Kg. Smooth operation is guaranteed through the use of the highest quality fittings.



DESIGN FEATURES

- Accepts 20 – 31mm double glazing
- Max 400kg panel weight
- Certified PAS 24
- Anti bi-metal polyamide strip to allow for varying expansion rates

OPTIONS

- Available as Lift & Slide
- Slimmer sightline of 45mm available
- Multiple sliding configurations
- Mono, Dual or Tri rail options
- Available in single and dual colour; anodised finishes also available
- Range of hardware and security features

SPECIFICATIONS

Performance and accreditation	BSC94
U-value (double Glazing)* (Ug = 1.0W/m ² K) (Mono Rail)	1.7 W/m ² K
U-value (triple Glazing)* (Ug = 0.7W/m ² K) (Mono Rail)	1.5 W/m ² K
U-value (double Glazing)* (Ug = 1.0W/m ² K) (Dual Rail)	1.9 W/m ² K
U-value (triple Glazing)* (Ug = 0.7W/m ² K) (Dual Rail)	1.7 W/m ² K
Green guide rating	C rated
Acoustic performance (dB)	Rw (C;Ctr) 36 (-1;-3) dB**
Air tightness (Pa)***	Class 4 (600 Pa)
Water tightness (Pa)***	Class 7a (300 Pa)
Wind load (Pa)***	C4 (1600 Pa)
Security – PAS24	✓
Configuration & frame	
Opening	Inline sliding
Mono rail (105mm)	✓
Dual rail (94mm)	✓
Tri rail (155mm)	✓
Size limits	
Max vent weight****	400kg
Max frame height*	3000mm
Max frame height with security features	2600mm
System features	
Dual colour option	✓
Multi-point locking	✓
Glazing options	Internal
Glazing thickness	20mm-31mm
Sightlines	85mm

Performance and accreditation	BSC94SLIM
U-value (double Glazing)* (Ug = 1.0W/m ² K) (Mono Rail)	x
U-value (triple Glazing)* (Ug = 0.7W/m ² K) (Mono Rail)	x
U-value (double Glazing)* (Ug = 1.0W/m ² K) (Dual Rail)	1.9 W/m ² K
U-value (triple Glazing)* (Ug = 0.7W/m ² K) (Dual Rail)	1.6 W/m ² K
Green guide rating	C rated
Acoustic performance (dB)	npd
Air tightness (Pa)***	Class 4 (600 Pa)
Water tightness (Pa)***	Class 7a (300 Pa)
Wind load (Pa)***	C4 (1600 Pa)
Security – PAS24	x
Configuration & frame	
Opening	Inline sliding
Mono rail (105mm)	x
Dual rail (94mm)	✓
Tri rail (155mm)	✓
Size limits	
Max vent weight****	400kg
Max frame height*	3000mm
Max frame height with security features	x
System features	
Dual colour option	✓
Multi-point locking	✓
Glazing options	Internal
Glazing thickness	20mm-31mm
Sightlines	45mm

CAD CROSS SECTIONS

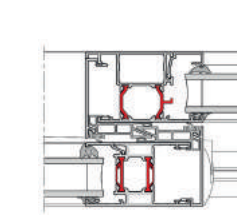

Mono Rail – Interlock

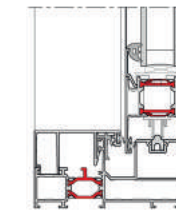

Mono Rail – Cill

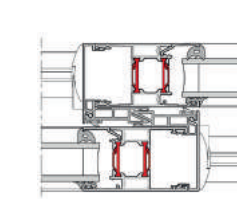

Dual Rail/Tri Rail – Standard Interlock

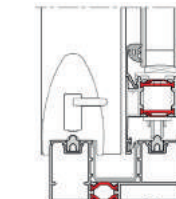

Dual Rail – Cill

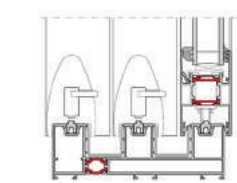

Tri Rail – Cill

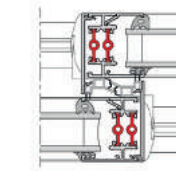

Dual Rail/Tri Rail – Standard Slimline Interlock

*U-Values based on CEN size door (2000mm x 2180mm).
 **Sound insulation values are Rw reduction values and are based on tests using acoustic glazing.
 ***All weather test data taken from BS EN 6375-1 based upon highest performing door configuration.
 ****Based on using double rollers.
 *Dependent on wind load and lock variation.
 Note: npd = No performance declared.
 Please visit www.aluk.co.uk to download all BIM components and CAD files.





**Ready for the
Royale treatment?**

